

THE PRODUCT COMPENDIUM

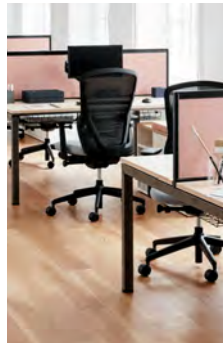

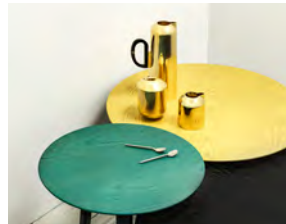

Ad-Lib



IT JUST GOT BETTER

Created with collaboration and versatility in mind, the Ad-Lib Table collection designed by PearsonLloyd, now offers an even wider range of finishes and configurations.

Designed to support small impromptu gatherings or larger group meetings, power, HDMI and powered USB outlets are conveniently located under the desk surface and accessed through an easily removable polished acrylic cable access tray.

The tables also now feature an innovative tech knit sock that acts as cable management.

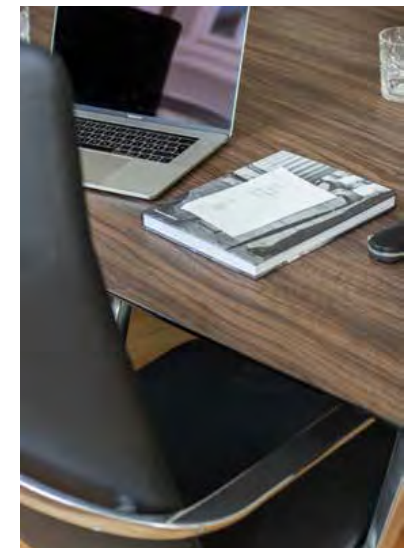

Ad-Lib Tables

Looking at how people work, the Ad-Lib range has evolved and now offers new top shapes and sizes. With technology at the forefront of the design; power, AV and USB outlets are conveniently located and accessed through an easily removable cable access tray.



EXAMPLE CONFIGURATION

When working in collaboration, it is often necessary for conversations to take place away from the desk. Small but dedicated areas like this provide an informal space for short meetings, making efficient use of a space.

EXAMPLE CONFIGURATION

The nature of the space drives its use. A formal meeting area will encourage more structured presentations, a larger meeting space with integrated power enables participants to charge devices and interact throughout.





Ad-Lib Tables

Ad-Lib Work Lounge tables are the latest addition to the Ad-Lib range, created using softer lines to enhance visual communication and remove the barriers to workflow.



EXAMPLE CONFIGURATION

Simple details can greatly influence the tone of a meeting. Subtle curves in a table can add informality to put people at ease. A central column eases leg comfort and easy access to power minimises disruptions.

EXAMPLE CONFIGURATION

The right mixture of resources can create a communal space ideal for brainstorming or quick fire sharing of thoughts. This zone makes it easy to jot down and share ideas between colleagues.



Pivot

Pivot tables actively adapt and change with the needs of today's training, meeting and conference environments. Pivot tables allow for individual use, small groups and can be reconfigured easily with its one touch release mechanism, into larger more diverse configurations and function layouts.

EXAMPLE CONFIGURATION

The U shape setup is well suited to training environments as it creates a relaxed space that allows the presenter to engage with the audience.



EXAMPLE CONFIGURATION

In a learning setting the focus is almost always on the presenter, usually with little interaction required. This space should be suitably comfortable for reasonable periods of time to keep the audience engaged.



Axis

Axis is an innovative and functional table system. Designed around a patented hinge, the table frame folds within its own length for ease of reconfiguration, storage and transportation.



EXAMPLE CONFIGURATION

Conference rooms and meeting rooms need not be traditional in layout. By changing the angles of a meeting table, you can improve the visual lines of communication to improve collaboration.

EXAMPLE CONFIGURATION

This is the traditional layout for learning and training environments, where the focus is on the presenter and not the other members in the audience. Work surfaces should be generous enough to support more than one device.



Chameleon

Chameleon is a simple but elegant table system. The uncluttered detailing allows the tables to be used either individually or arranged to suit a wide range of different spatial and functional requirements.

EXAMPLE CONFIGURATION

A U configuration shape setup is well suited to training environments as it creates a relaxed space that allows the presenter to engage with the audience.

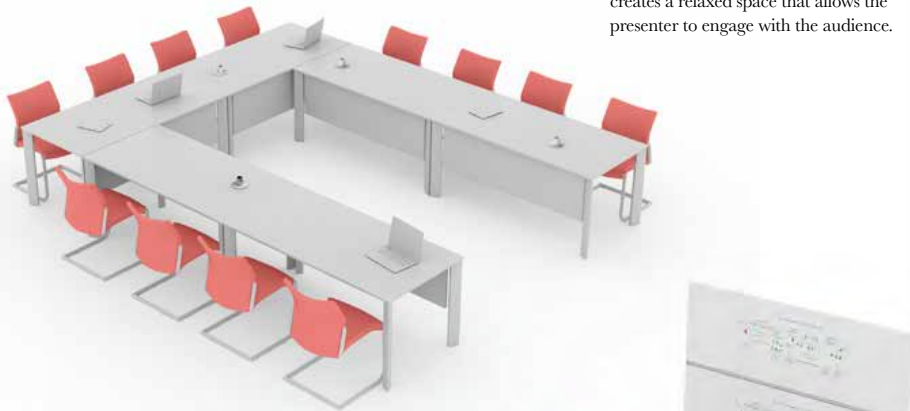

EXAMPLE CONFIGURATION

A formal layout sets the tone of a meeting. One person leads and invites others to comment. Multimedia and white boards can be close at hand for professional and engaging presentations.



Play

The Play meeting table has an elegant poise with its slimline leg and oversized levelling adjuster. Its visual lightness masks the table's strength.



EXAMPLE CONFIGURATION

When working in collaboration, it is often necessary for conversations to take place away from the desk. Small but dedicated areas like this provide an informal space for short meetings, making efficient use of a space.

EXAMPLE CONFIGURATION

The right mixture of resources can create a communal space ideal for brainstorming or quick fire sharing of thoughts. This zone makes it easy to jot down and share ideas between colleagues.

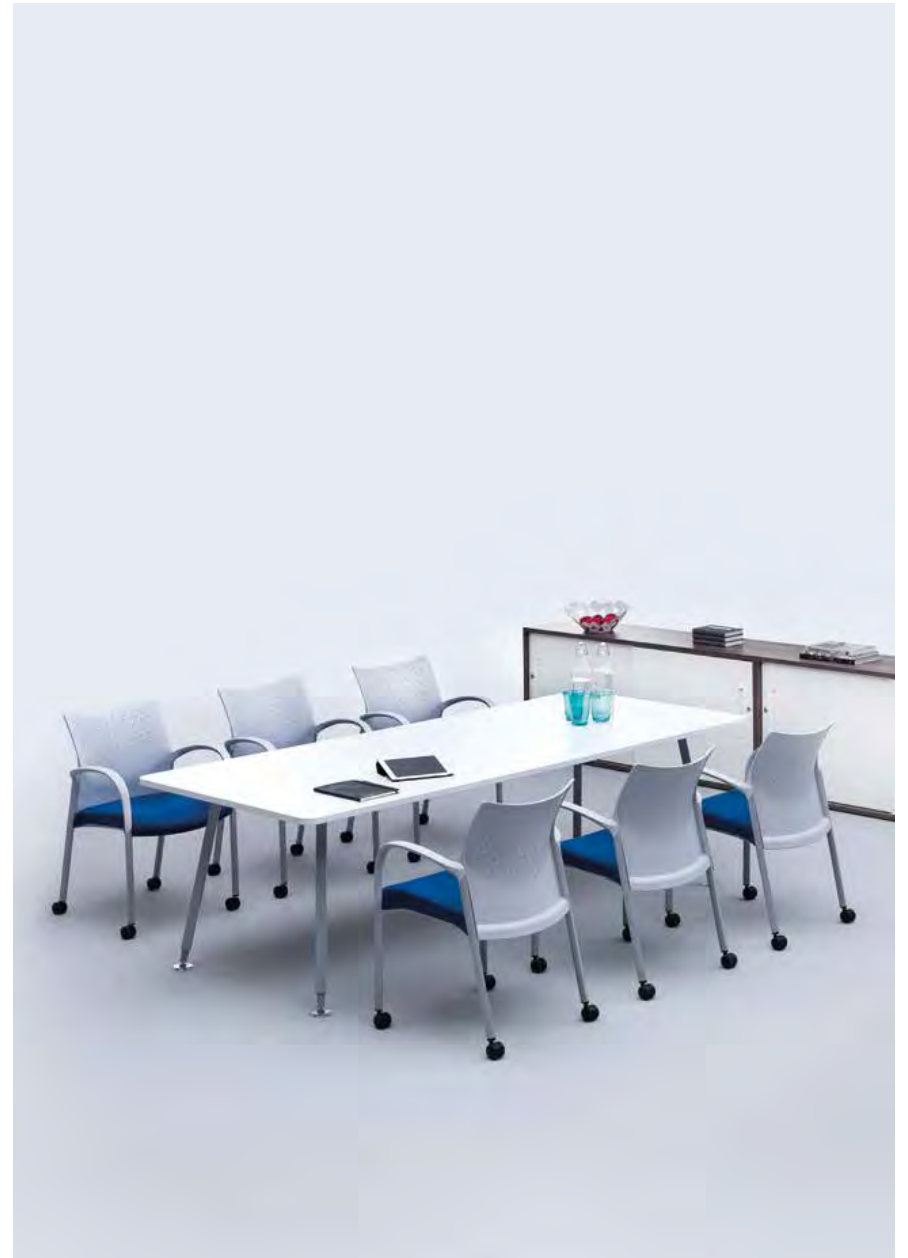

Pailo



BRINGING WORK, HOME

As we continually move towards the desire for a more domestic working environment, Pailo provides a softer approach to the more formal bench desking systems that explores new ways to introduce fabric into the workplace. The range incorporates single and back to back desks as well as multiple project tables to suit both formal and informal working styles.

For keeping personal belongings off the floor and close to hand, Pailo includes the optional addition of a suspended wire caddy, providing an easily accessible space with multiple shelves. Pailo's cloud screens create a place to pin ideas or notes to remember, mounting directly to the understructure of the desk to give the illusion that they are free floating.

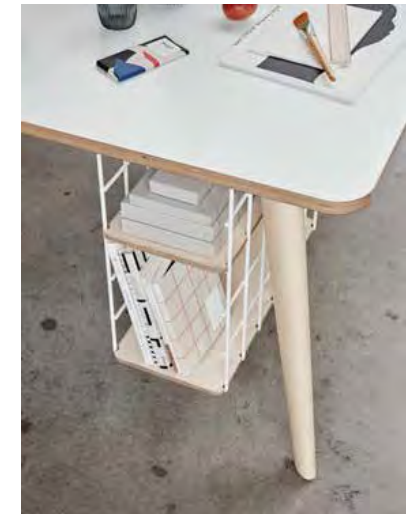

Pailo

Pailo provides a softer approach to the more formal bench desking systems that explores new ways to introduce fabric into the workplace. The range incorporates single and back to back desks as well as multiple project tables to suit both formal and informal working styles.



EXAMPLE CONFIGURATION

For keeping personal belongings off the floor and close to hand, Pailo includes the optional addition of a suspended wire caddy, providing an easily accessible space with multiple shelves.

EXAMPLE CONFIGURATION

Pailo's cloud screens create a place to pin ideas or notes to remember, mounting directly to the understructure of the desk to give the illusion that they are free floating.





Orb

Orb allows instant ad-hoc configurations between co-workers that can often prove the most insightful. Creating a structure to a space that fosters a fluid working style and an environment that encourages movement and interaction is fundamentally important.



EXAMPLE CONFIGURATION

This is an alternative variation of a four person desk system for employees that will be based at the desk around 8 hours a day. A change in desk shape can help make the space more visually interesting.

EXAMPLE CONFIGURATION

Areas that support solo and team working often benefit from a breakout space close to hand. Encouraging a change of posture when working has been known to improve productivity and help with focus.



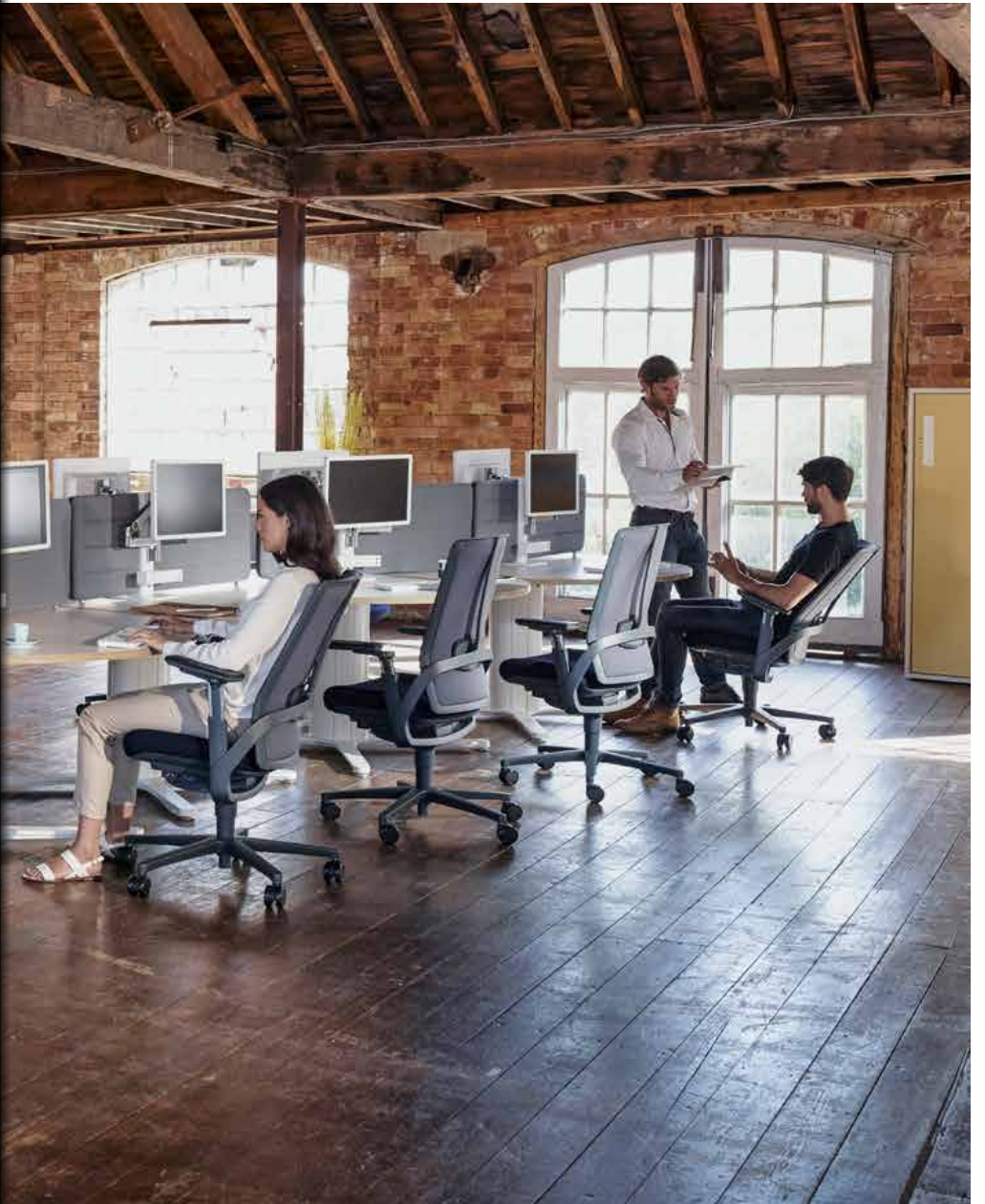



Chemistry

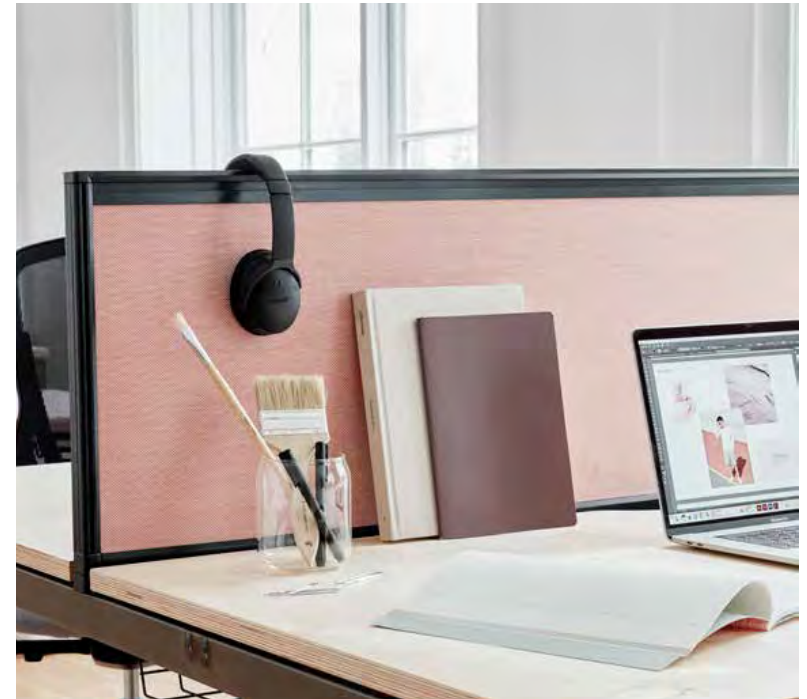

MODERN ENVIRONMENT

The Chemistry range of workstations has been developed for modern working environments. Chemistry creates a stylish yet flexible solution that improves productivity and facilitates diversity for individuals and teams.

Chemistry Workstations can be configured as individual desks or as bench solutions that share components, allowing for the integration of partitions that form touch down workstations or meeting spaces.

The range incorporates two leg styles and the ability to integrate sliding tops for ease of access to integrated cable management.

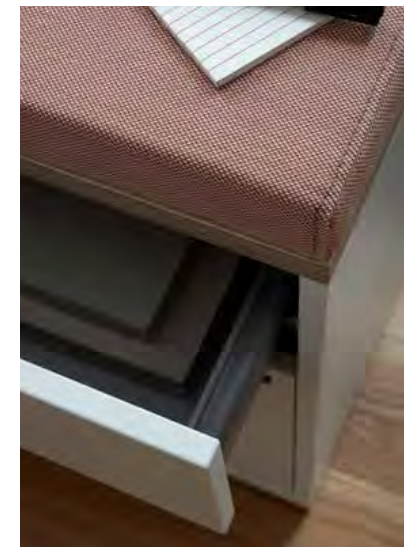

Chemistry

The Chemistry range of workstations have been developed for modern working and learning environments. Chemistry creates a stylish yet flexible solution which improves productivity and facilitates diversity for individuals and teams.



EXAMPLE CONFIGURATION

This two person bank of desks is an ideal supervisory workspace for an open plan office or library. Set away from the main clusters with plenty of personal storage for filing and screens for focus.

EXAMPLE CONFIGURATION

Private offices can also be flexible spaces, the addition of a seating area allows quick meetings to take place if required. In the absence of the occupant another manager may make use of the space.

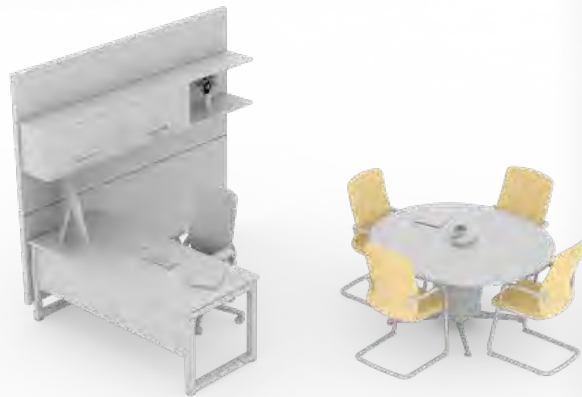

Chemistry

Chemistry Meeting Tables share the same frame as Chemistry Workstations for a consistent design aesthetic. Options for in desk power and cable management provide practical features.



EXAMPLE CONFIGURATION

A flexible space that supports all types of nomadic workers, this split workstation allows users to either work from a laptop or log on and connect through a fixed computer.



EXAMPLE CONFIGURATION

In touch down areas, communal storage can be used as a place to hold personal belongings temporarily as well as resources that are less frequently accessed.







Chemistry Height Adjustable



REACHING NEW HEIGHTS

Height adjustable desks have been widely recognised as an aid to employee wellbeing and productivity. Chemistry workstations designed to fully interact with the user, whether that be seated or standing, height adjustable desks permit the user to quickly set their optimum working height by means of a manual adjustment or responsive push button electronic mechanism.



Chemistry

Chemistry features a back to back height adjustable bench leg option that allows the user to quickly set their optimum working height by means of a responsive manual adjustment or via a push button electronic mechanism.



EXAMPLE CONFIGURATION

Height adjustable desking can be beneficial as studies have shown a change in posture can aid concentration. Pull out storage can also offer additional privacy in an area like this.

EXAMPLE CONFIGURATION

Height adjustable workstations create an area that supports laptop users and can be easily adjusted to suit individual preferences, ideal for those using the space for a short period of time.



Chemistry

Chemistry incorporates a height adjustable workstation solution allowing the user the option to vary their posture and stand whilst working.



EXAMPLE CONFIGURATION

A combination of height adjustable desking and meeting tables is an ideal set-up for open spaces, where a range of postural requirements need to be catered for.

EXAMPLE CONFIGURATION

Single height adjustable desks can create inline set ups, where space requirements may be narrow or limited.



